

# CATÁLOGO 2024

## DE PRODUCTOS



REDUCE 20 °C

**MARAVI**



Clic para asesoría  
vía Whatsapp

 [informes@corporacionmaravi.com](mailto:informes@corporacionmaravi.com)

 [www.corporacionmaravi.com](http://www.corporacionmaravi.com)

 Corporacion Maravi

 Corporacion Maravi

 951 791 331



Clic para asesoría  
vía Whatsapp

## NOSOTROS

Somos una empresa con amplia experiencia en el sector industrial, pesquero, agroindustrial, comercial, hospitalario y doméstico; utilizando tecnología acorde a la necesidad de nuestros clientes, comprometidos con el medio ambiente.

Nuestro producto de resina virgen sanitario, lavable, aséptico, inocuo certificados por normativa vigente, aprobado por DIGEMID – DIGESA; SANIPES; ITP, entre otros.

 [informes@corporacionmaravi.com](mailto:informes@corporacionmaravi.com)

 [www.corporacionmaravi.com](http://www.corporacionmaravi.com)

 Corporacion Maravi

 Corporacion Maravi

 951 791 331



# PANELES INDUSTRIALES Y SANITARIOS DE PVC



Clic para asesoría  
vía Whatsapp

## CARACTERÍSTICAS

- ✓ Térmicos
- ✓ Acústicos
- ✓ Eternos
- ✓ No Tóxicos
- ✓ Acabado superior
- ✓ Cero mantenimiento
- ✓ Resistente a Químicos
- ✓ Resistente a impactos
- ✓ Machihembrado perfecto

## BENEFICIOS DE LOS PANELES



NO PROPAGA  
LLAMAS



FÁCIL  
INSTALACIÓN



100% RESISTENTE  
A LA HUMEDAD



CERO  
MANTENIMIENTO  
Y PINTURAS



MATERIAL  
100%  
RECICLABLE



LIBRE AL  
HONGO Y LA  
CORROSIÓN

Ancho : 20.00 cm útiles.  
Espesor : 10.00 mm  
Largo : 5.00 m ó a solicitud  
de cliente



RECICLABLE



RECICLABLE



RECICLABLE

Recomendación de uso:  
Cielos Rasos, Tabiquerías y Revestimientos.



✉ informes@corporacionmaravi.com

🌐 www.corporacionmaravi.com

📘 Corporacion Maravi

📷 Corporacion Maravi

☎ 951 791 331



Clic para asesoría  
vía Whatsapp

**PERFIL J**



**PERFIL H**

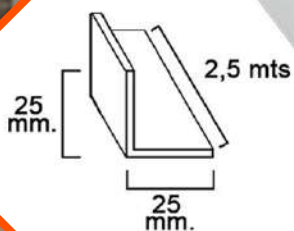

**PERFIL L**

**PERFIL SANITARIO  
PVC TIPO CORNISA**



**PERFIL TIPO  
PECHO DE PALOMA**





# PANELES INDUSTRIALES Y SANITARIOS DE PVC



Clic para asesoría  
vía Whatsapp



 [informes@corporacionmaravi.com](mailto:informes@corporacionmaravi.com)

 [www.corporacionmaravi.com](http://www.corporacionmaravi.com)

 Corporacion Maravi

 Corporacion Maravi

 951 791 331

# PANELES INDUSTRIALES Y SANITARIOS DE PVC

 **Clic para asesoría vía Whatsapp**



**OFICINAS**



**INDUSTRIAS**



**GIMNASIOS**



**CRADEROS**



**LABORATORIOS**



**AGRO INDUSTRIAS**



**CLÍNICAS**



 [informes@corporacionmaravi.com](mailto:informes@corporacionmaravi.com)  
 [www.corporacionmaravi.com](http://www.corporacionmaravi.com)  
 Corporacion Maravi  
 Corporacion Maravi  
 951 791 331



Clic para asesoría  
vía Whatsapp

# ZÓCALOS SANITARIOS DE PVC

## CARACTERÍSTICAS

- ✓ Zócalo Sanitario de PVC
- ✓ Fácil instalación
- ✓ Fácilmente adaptable
- ✓ Fácil limpieza
- ✓ Resistente al impacto
- ✓ Tamaño ideal
- ✓ Riel de anclaje

## BENEFICIOS DE LOS ZÓCALOS SANITARIOS



NO PROPAGA  
LLAMAS



FÁCIL  
INSTALACIÓN



100% RESISTENTE  
A LA HUMEDAD



CERO  
MANTENIMIENTO  
Y PINTURAS



MATERIAL  
100%  
RECICLABLE



LIBRE AL  
HONGO Y LA  
CORROSIÓN

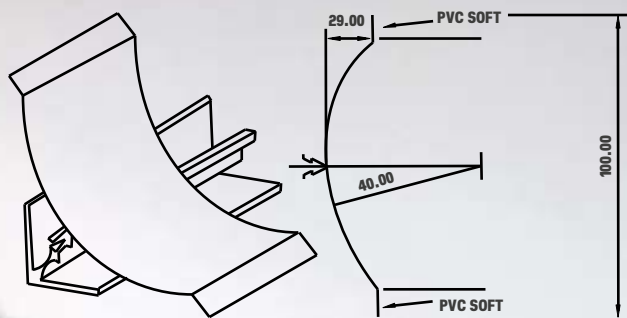

RECICLABLE



RECICLABLE

Recomendación de uso:  
Cielos Rasos, Tabiquerías y Revestimientos.

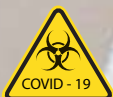



# ZÓCALOS SANITARIOS DE PVC



Clic para asesoría  
vía Whatsapp



Ministerio de Salud  
**DIGESA**  
DIRECCIÓN GENERAL DE  
SALUD AMBIENTAL



**SENASA**  
— PERU



✉ [informes@corporacionmaravi.com](mailto:informes@corporacionmaravi.com)

🌐 [www.corporacionmaravi.com](http://www.corporacionmaravi.com)

📘 Corporacion Maravi

📷 Corporacion Maravi

📞 951 791 331





Clic para asesoría  
vía Whatsapp



**OFICINAS**



**INDUSTRIAS**



**GIMNASIOS**



**CRIADEROS**



**LABORATORIOS**



**AGRO  
INDUSTRIAS**



**CLÍNICAS**





Clic para asesoría  
vía Whatsapp

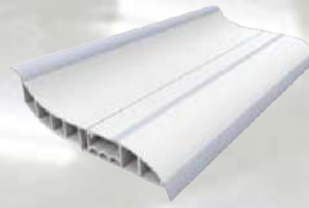

Perfil de borde inferior higiénico

**SP059**

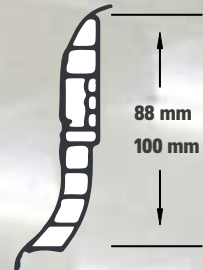

Esquina  
conector



**NP 001**

Esquina  
interna



Esquina  
externa



**NP 002**

Cubierta lateral  
Derecha - izquierda



**NP 003 R-L**



Panel PVC para Cuarto de Frio

**SP053**

80 cm. Perfil PVC

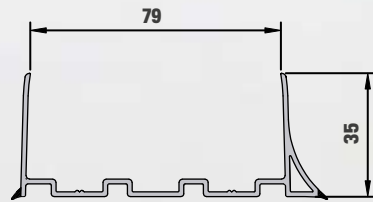
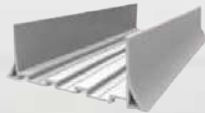

**SP005**

100 cm. Perfil PVC

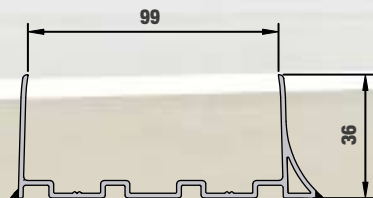
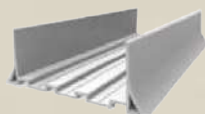



# THERMO PANELES INDUSTRIALES DE PVC



Clic para asesoría  
vía Whatsapp

## CARACTERÍSTICAS

- ✓ Térmicos
- ✓ Acústicos
- ✓ Acabado superior
- ✓ Cero mantenimiento
- ✓ Resistente a Químicos
- ✓ Machihembrado perfecto

## BENEFICIOS DE LOS PANELES



NO PROPAGA  
LLAMAS



FÁCIL  
INSTALACIÓN



100% RESISTENTE  
A LA HUMEDAD



CERO  
MANTENIMIENTO  
Y PINTURAS



MATERIAL  
100%  
RECICLABLE



LIBRE AL  
HONGO Y LA  
CORROSIÓN

Placa PVC Alveolar de 10 mm.  
Núcleo aislante de poliestireno  
Medida de Formato Comercial:  
Largo: 2.40 mt  
Ancho: 1.00 mt  
Espesor: 50.00 mm



RECICLABLE



informes@corporacionmaravi.com

www.corporacionmaravi.com

Corporacion Maravi

Corporacion Maravi

951 791 331



# THERMO PANELES INDUSTRIALES DE PVC



Clic para asesoría  
vía Whatsapp



 [informes@corporacionmaravi.com](mailto:informes@corporacionmaravi.com)

 [www.corporacionmaravi.com](http://www.corporacionmaravi.com)

 Corporacion Maravi

 Corporacion Maravi

 951 791 331



Clic para asesoría  
vía Whatsapp

**SALAS DE  
CLIMATIZACIÓN**

**CÁMARAS DE  
CONGELACIÓN**

**CÁMARAS  
FRIGORIFICAS**

**CONSTRUCCIONES  
MODULARES**





Clic para asesoría  
vía Whatsapp

# COBERTURAS DE UPVC

## CARACTERÍSTICAS

Resistencia a la flexión	81 kgf
Resistencia a la tensión	290 Kg / cm <sup>2</sup>
Absorción de Agua	0,005 %
Cambios por aumento y disminución de temperatura	0,8 %
Coefficiente de transmisión de calor	0,0643 W / m <sup>2</sup> K
Temperatura de ablandamiento	73 °C
Aislación acústica	12 dB app
Radio de curvatura	15 mts.
Largo	Longitud máxima: 11.80 mts., 5.80 mts.
Ancho total	0.94 mts. - 1.07 mts.
Espesor	2 mm, 2.5 mm, 3 mm, 3.5 mm.
Ancho útil	0.88 mts. - 0.98 mts.
Altura de cresta	40 mm.
Distancia entre crestas	176 mm.
Peso específico	4.53 kg/m <sup>2</sup> en 2mm de espesor, 5.80 kg/m <sup>2</sup> en 2.5 mm de espesor





# COBERTURAS DE UPVC



Clic para asesoría  
vía Whatsapp

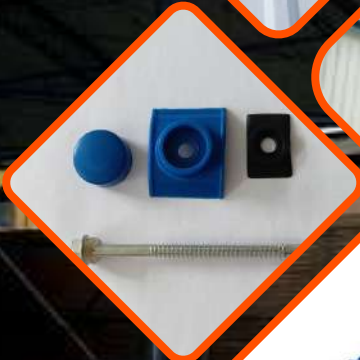
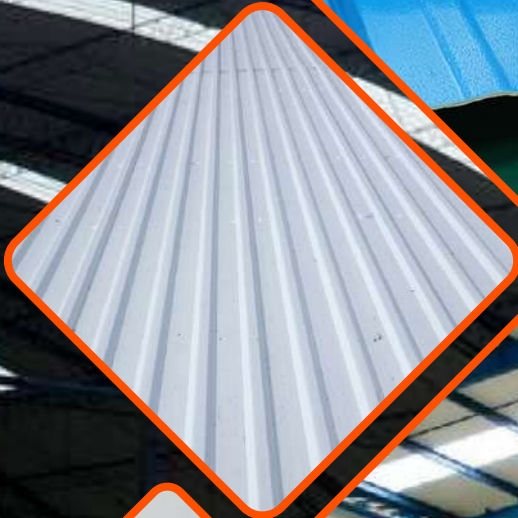

✉ informes@corporacionmaravi.com

🌐 www.corporacionmaravi.com

📘 Corporacion Maravi

📷 Corporacion Maravi

📞 951 791 331



Clic para asesoría  
vía Whatsapp

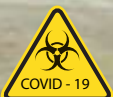





## INSTALACIÓN DE ZÓCALOS DE PVC

RENDIMIENTO : 50ml x cuadrilla.  
CANTIDAD X CUADRILLA : 1 operario, 1 ayudante.  
ACCESORIOS DE TRABAJO : taladros, tarugos, tijera, atornillador, aplicador y silicona.  
PESO POR ML : 850 kg/MI  
EPPS : protector, zapatos, pantalones jean, camisa manga larga, chaleco  
TIPO DE SEGURO : sctr pension, sctr salud, exámen médico.



## INSTALACIÓN DE PANELES DE PVC

RENDIMIENTO: 90 ML x cuadrilla al 100%  
RENDIMIENTO MÁS DE 3 MT: 70 ML x cuadrilla (según disponibilidad de andamios)  
PERFILES DE PVC: Perfil U, Perfil H, Perfil L  
PERFIL GALVANIZADO: riel, parante, omega (liviano)\*  
PERFIL GALVANIZADO: riel, parante, omega (pesado)\*  
CANTIDAD X CUADRILLA: 1 operario, 1 oficial, 1 ayudante  
ACCESORIOS DE TRABAJO: taladros, tijera, atornillador, aplicador, silicona, amoladora, tornillo tipo wafer, escuadra, andamios normados,  
PESO X M2: 3,750 kg/M2  
EPPS: Protector, zapatos, pantalones jean, camisa manga larga, chaleco, barbiquejos, lentes, respiradores, arnés y línea de vida  
TIPO DE SEGURO: sctr pension, sctr salud, exámen médico ocupacional (pre, durante y retiro), permiso de trabajos de altura (según sea el caso)



## INSTALACIÓN DE COBERTURAS DE UPVC

RENDIMIENTO DE MAS DE 3MT: 90 ML x cuadrilla ( según dificultad del área).  
PERFILES DE PVC : CUMBRERAS DE PVC  
CANTIDAD X CUADRILLA : 2 operarios, 1 oficial, 1 ayudante  
ACCESORIOS DE TRABAJO: taladros, atornillador, aplicador, silicona, amoladora, tornillo, andamios normados, capuchones.  
PESO X M2 : 4.53 kg/m2 en 2 mm de espesor.  
5.80 kg/m2 en 2.5 mm de espesor.  
6.67 kg/m2 en 3 mm de espesor.  
EPPS : Protector, zapatos, pantalones jean, camisa manga larga, chaleco, barbiquejos, lentes, arnés y línea de vida.  
TIPO DE SEGURO: sctr pension, sctr salud, examen médico ocupacional (pre, durante y retiro), permiso de trabajos en altura (según sea el caso).





Clic para asesoría  
vía Whatsapp

# BALDOSAS DE PVC

## CARACTERÍSTICAS

Peso específico	1.8 kg. ± 0.1
IZOD-intensidad impacto ( kg-cm/M2)	Superior a 6.0
Intensidad extensible ( kg-cm/M2)	Superior a 8.0
Rigidez de impresión	Capa de impresión separadas > 3
Rigidez de UV-curing	Cinta estandar
Componentes	Flexibilidad, resistencia, rigidez, control de espesor y mejora propiedades
Certificaciones	SONCAP
Borde	Recto
Aislamiento acústico	Absorbe la intensidad de ruido en un 14.87% en promedio
Resistencia térmica	Coefficiente de resistividad térmica promedio 0.19 (m2.K/W)
Seguridad contra incendios	Índice de propagación de llama 4.07 Clase (RE2)
Resistencia calórica	No cambia sus características físicas hasta los 83° C
Densidad	1.85 Densidad g/cm3
Dureza	Dureza, Shore D71.11
Grado de inflamabilidad	V.0

## OPCIONES DE COMPRA

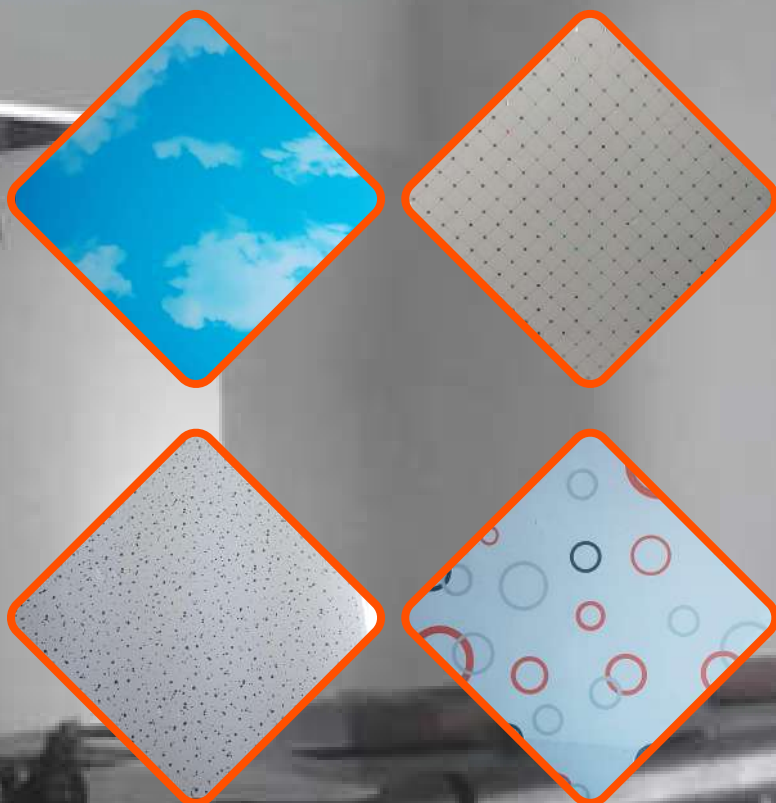

✉ informes@corporacionmaravi.com

🌐 www.corporacionmaravi.com

📘 Corporacion Maravi

📷 Corporacion Maravi

☎ 951 791 331



Clic para asesoría  
vía Whatsapp



# BALDOSAS DE PVC

## CARACTERÍSTICAS

- ✓ Térmicos
- ✓ Acústicos
- ✓ Eternos
- ✓ No Tóxicos
- ✓ Acabado superior
- ✓ Cero mantenimiento
- ✓ Resistente a Químicos
- ✓ Resistente a impactos
- ✓ Machihembrado perfecto

## BENEFICIOS DE LAS BALDOSAS



NO PROPAGA  
LLAMAS



FÁCIL  
INSTALACIÓN



100% RESISTENTE  
A LA HUMEDAD



CERO  
MANTENIMIENTO  
Y PINTURAS



MATERIAL  
100%  
RECICLABLE



LIBRE AL  
HONGO Y LA  
CORROSIÓN

Ancho : 20.00 cm útiles.  
Espesor : 10.00 mm  
Largo : 5.00 m ó a solicitud  
de cliente

Recomendación de uso:  
Cielos Rasos, Tabiquerías y Revestimientos.



informes@corporacionmaravi.com

www.corporacionmaravi.com

Corporacion Maravi

Corporacion Maravi

951 791 331



# BALDOSAS DE PVC



Clic para asesoría  
vía Whatsapp

**BOTICAS**

**HOTELES**

**CENTROS  
COMERCIALES**

**OFICINAS**

**CLÍNICAS**



 [informes@corporacionmaravi.com](mailto:informes@corporacionmaravi.com)

 [www.corporacionmaravi.com](http://www.corporacionmaravi.com)

 Corporacion Maravi

 Corporacion Maravi

 951 791 331



**SOMOS SU ALIADO  
ESTRATÉGICO...**



Clic para asesoría  
vía Whatsapp